



FADPRT2



By Appointment to
Her Majesty Queen Elizabeth II
Suppliers of Commercial Refrigeration
Foster Refrigerator, King's Lynn

English



Een onderdeel van ITW Ltd

Foster Refrigerator

Oldmedow Road

A Division of ITW Ltd

Foster Refrigerator
Oldmedow Road
King's Lynn
Norfolk, PE30 4JU
United Kingdom



Call: +44 (0)843 216 8800

Fax: +44 (0)843 216 4700
www.fosterrefrigerator.co.uk

Email: support@foster-uk.com



Climate Class

Climate class indicated on the serial plate, shows the temperature & humidity at which this appliance has been tested, for the purposes of establishing values in line with European standards.









Important Note to the Installer:

Please ensure that this document is passed to the user as it contains important guidelines on operation, loading, cleaning and general maintenance and should be kept for reference.

Electrical Safety

Foster Refrigerator recommends that the equipment is electrically connected via a Residual Current Device, such as a Residual Current Circuit Breaker (RCCB) type socket, or through a Residual Current Circuit Breaker with Overload Protection (RCBO) supplied circuit.

General Safety

-  Do not store explosive substances, such as aerosol cans with a flammable propellant, in this appliance.
-  Keep all ventilation openings in the appliance, or in the structure of a built in unit, clear of any obstructions.
-  Do not use electrical appliances inside the storage compartment.
-  The appliance is air tight when the door is closed, therefore under no circumstances should any living body be stored or 'locked in' the appliance.
-  The moving of the appliance should be carried out by competent personnel taking care to maintain the stability of the equipment at all times.
-  The emitted sound level of this appliance is 63db(A).
-  If the supply cord is damaged, it must be replaced by the manufacturer, it's service agent or similarly qualified persons.
-  Care should be taken to avoid prolonged contact with cold surfaces with unprotected body parts. Correct PPE should be used at all time.

Disposal Requirements

If not disposed of properly, these cabinets have components that can be harmful to the environment. All cabinets must be disposed of by appropriately registered and licensed waste contractors, and in accordance with national laws and regulations.

Introduction

Foster, Automatic, Defrost, Prove, Retard. 2 Trolley

The pizza processing operation is provided in three formats:

1. Fully automatic program incorporating all three functions.
2. Manual Thaw/store program.
3. Manual Prove/ Retard program.

The cabinet is designed to accommodate two special pizza trolleys.

The control system for each function displays time and temperature, allowing the operator to determine the status of the process.

Installation Instructions

Installation of these units should be carried out by a competent person and appropriate codes of practice adhered to, thus ensuring safe installation.

Removal Of The Panels From The Pallet

The cabinets are of modular construction with the wall panels and ancillary items delivered with retaining shrink-wrap. This exterior should be removed, which after cutting the bands will allow all the components to be removed and then checked for damage before placement in a convenient area for assembly. There could be more than one crate – so check each one as above.

Installation Of Panels And Equipment

The following instruction is suggested as a method of installation.

The ceiling panel is supplied with the refrigeration system / heater assembly pre-fitted, ready for installation, once the wall panels are erected.

The cabinets are floorless and therefore require fitting to a clean level floor.

The wall panels are attached to the floor by inserting them into PVC 'U' Channel. This is supplied cut and mitred and should be fitted to the floor prior to installation

Location

Flat, level, clean, sound surface.

This appliance has a top mounted system and will need a minimum of 300mm clearance above the unit.

Panel Layout and Dimensions

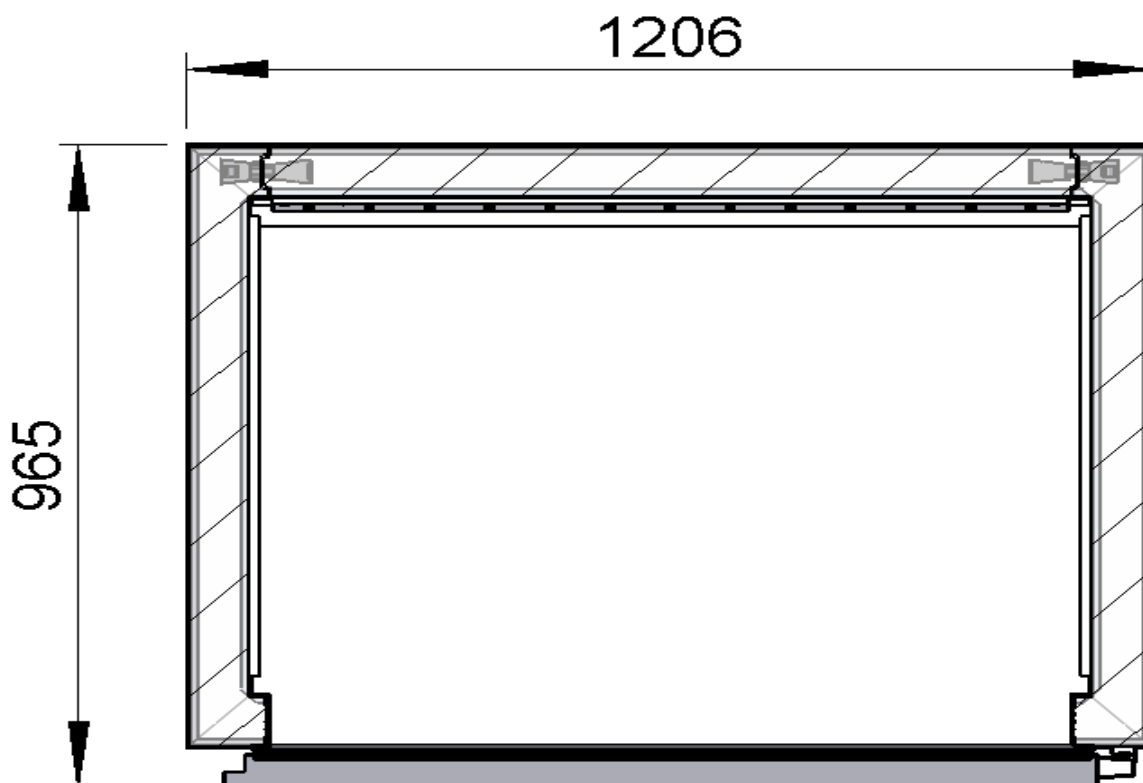

Ceiling panel with the refrigeration system / heater assembly

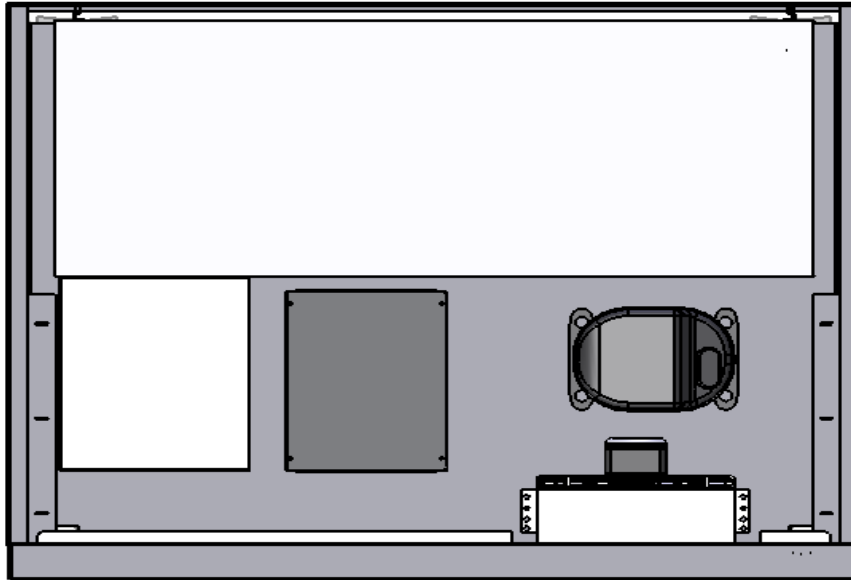

Cabinet Dimensions

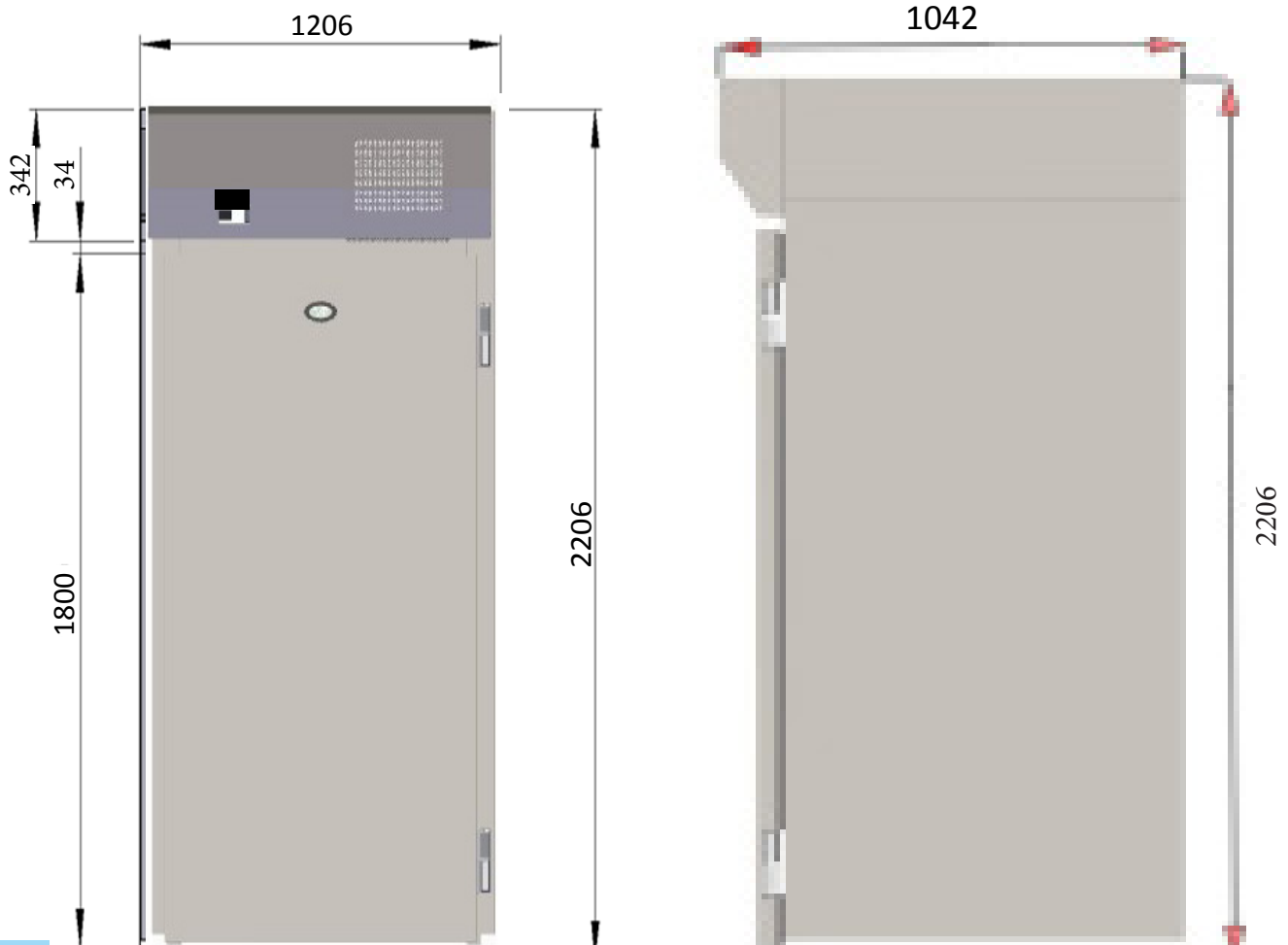

'U' Channel Fitting

The 'U' channel is supplied cut to the correct lengths.

The external dimensions of the room are - 1206mm Wide X - 1042mm Deep

It is important that the 'U' channel is fixed squarely so that the panels will lock together when inserted.



It is recommended that there should be no more than 3mm tolerance in the floor level, as this can affect the correct location of the panels.

Using a spirit level, check floor level on all four sides.

If required use packing shims to take up any anomalies in the floor.

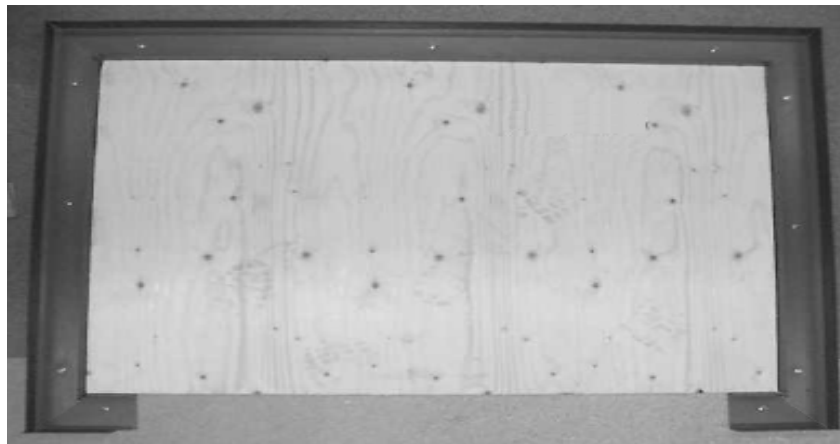

Once you are satisfied with the level, the U channel can be rawl-plugged or hilti-nailed into position, ensuring it is sealed with silicone sealer between the floor and the channel to prevent moisture penetration. Apply 'mastic sealer' to the inside of the channel to provide a vapour seal when the panels are located.

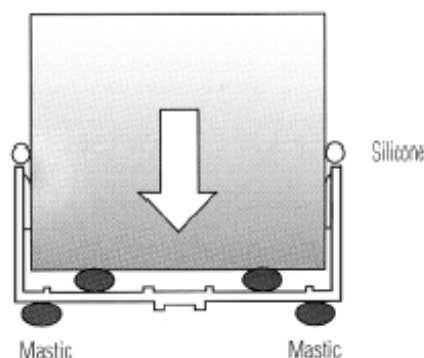

Assembly Of Wall Panel

Note: there is no door header panel, as this is integral with the ceiling panel.

Fit the side panel into the channel and apply a bead of mastic (see figs) to create a vapour seal. Place the rear panel in the channel, these can now be locked together (see fig 2). Repeat this process for the remaining panel until all panels are locked internally.

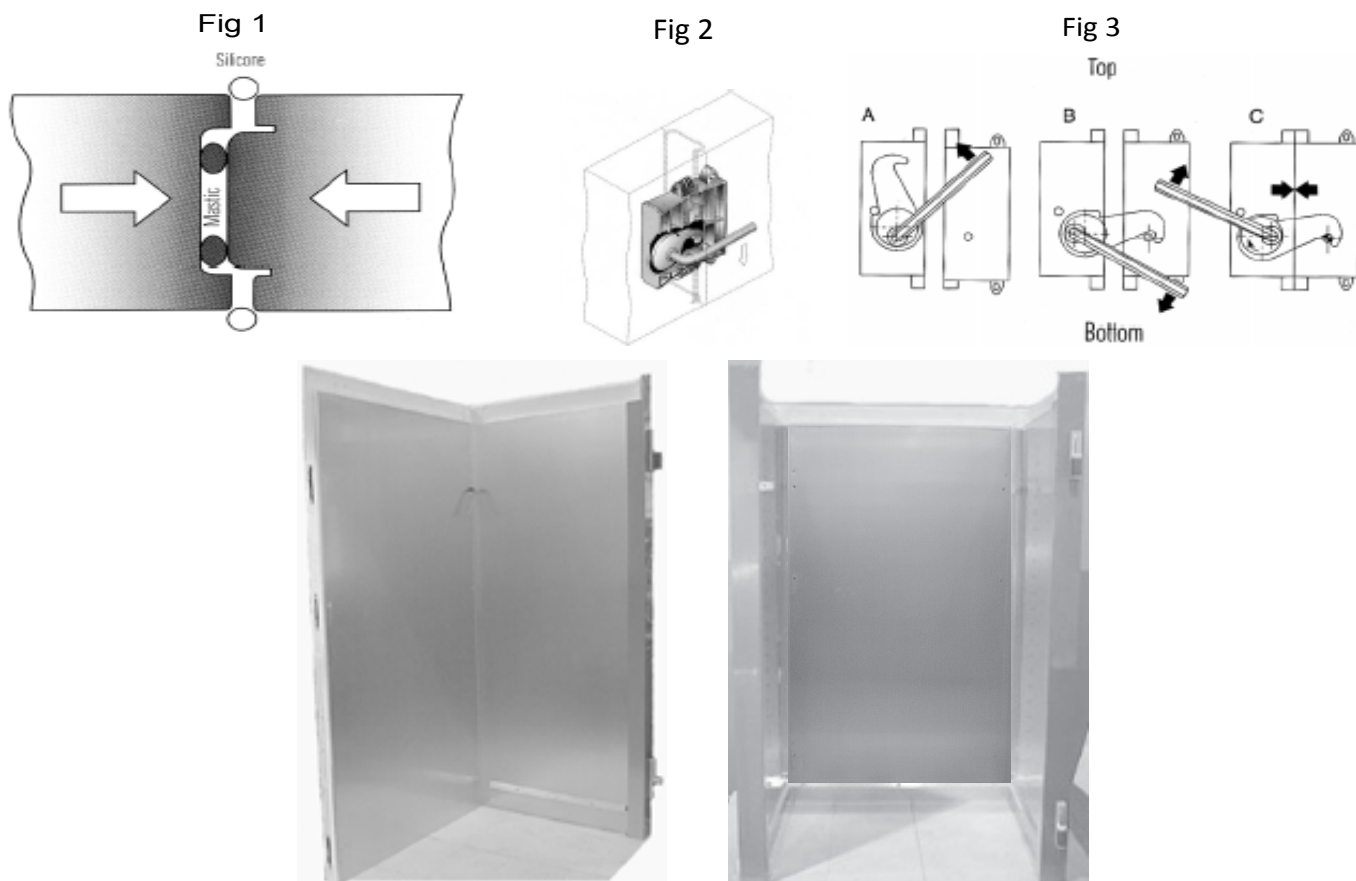

Fitting The Ceiling Panel

At the top of the wall panels there is a recess that accepts the ceiling.

Apply mastic to the recess so that when the panel is fitted there is a good vapour seal.

Slacken the screws securing the front panel to the sides and rest it securely on the top of the ceiling panel, taking care not to damage the interconnecting cables, See below.

Lift the ceiling panel complete and lower into the top recess.

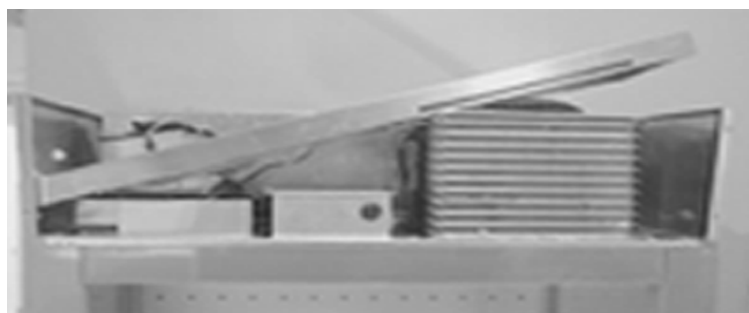

With the ceiling panel in place slide the galvanised angle bracket into place (see fig 4). Secure using the screws provided (see fig 5 and 6).

Fig 4



Fig 5



Fig 6



With the ceiling panel secured in place seal the internal joints with silicone sealer. Insert the buttons into the lock holes.

Fitting The Rear Air Duct

- 1) Prior to fitting the rear air duct check that the Air Return Duct is correctly located into the Coil Driptray Flange, see fig 7.
- 2) Place the air duct against the rear of the cabinet and insert into the space between the air return duct and the rear of the cabinet to a depth of 10mm, see fig 7, secure in place using the self tapping screws provided.

Fig 7

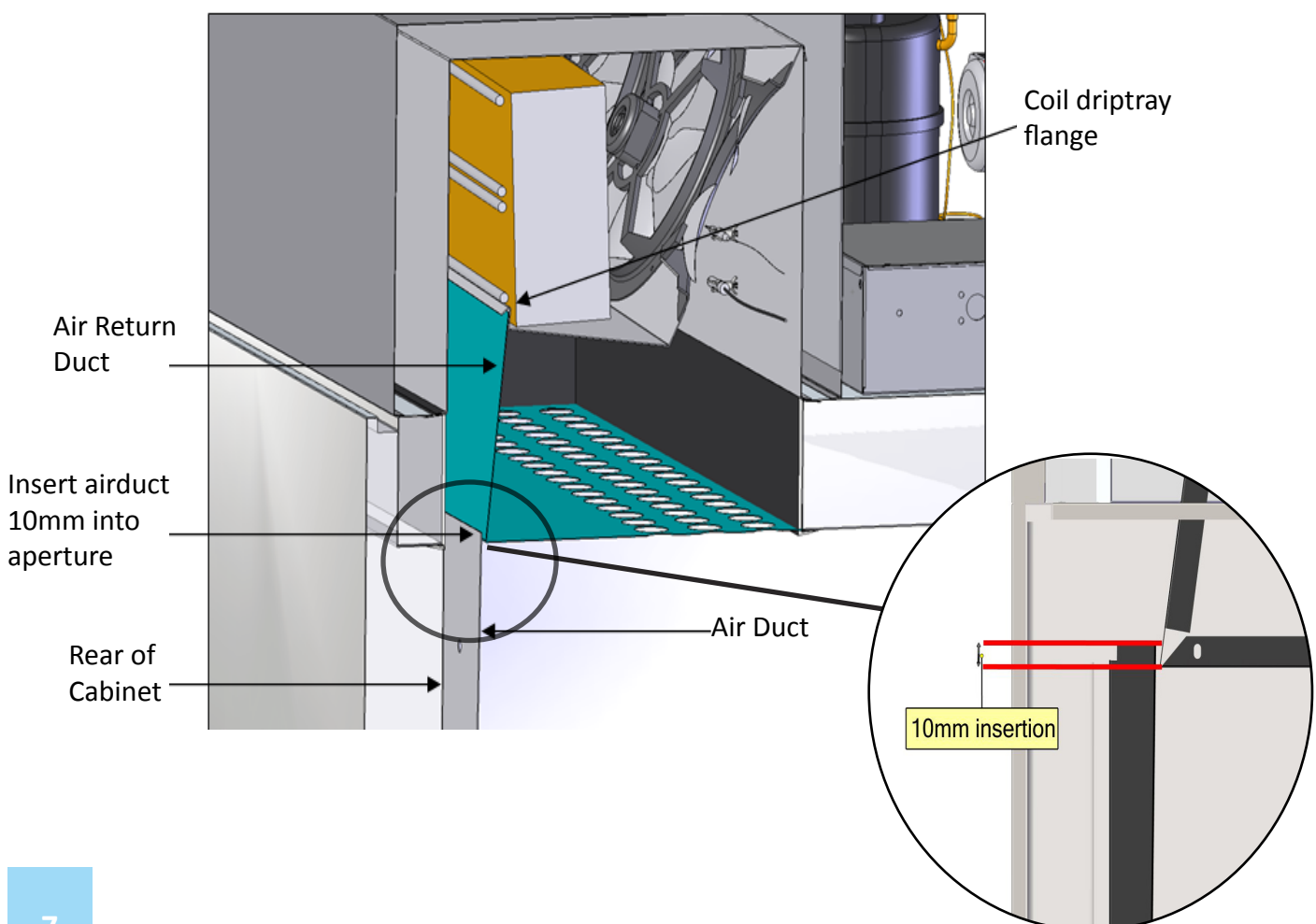

Fitting the Bumper Bar

The rear and side bumper bars at the height indicated, using the self tapping screws provided.

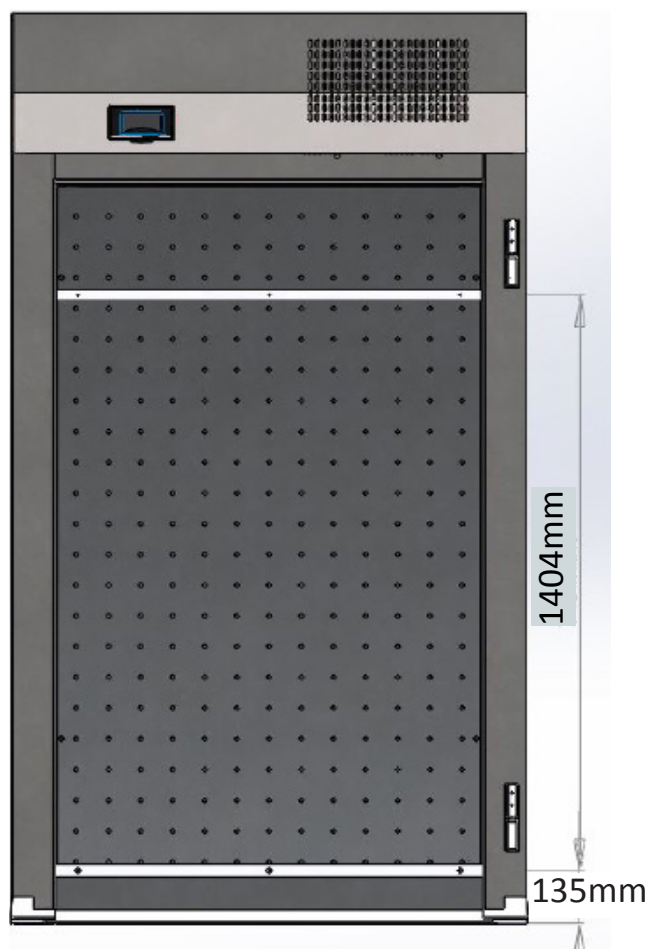
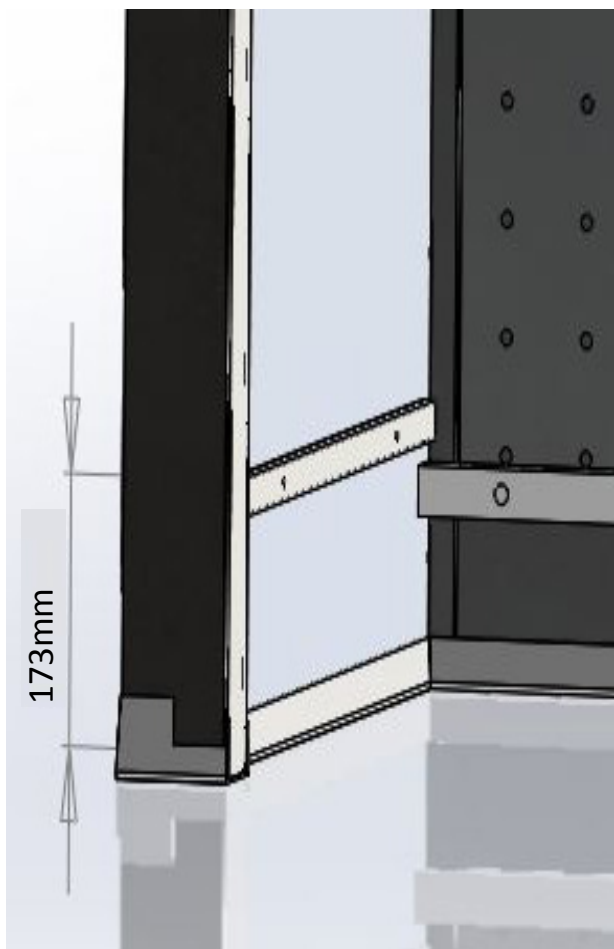

Fitting The Door

Hold the door at a 90° angle to the cabinet and lower the door on to the hinges, see (fig 10) for the correct hinge alignment in the closed position. Check that it hangs squarely to the cabinet.

Fig 8



Fig 9



Fig 10



Re-fit the unit cover and check that the top of the door lines up with the bottom of the unit cover.
To remove the door, reverse the process.
After hanging the door inspect the door gasket. Ensure that it seals fully to the doorframe.
Also ensure that the door wiper gasket, fitted to the bottom of the door is in contact with the floor (see fig 11).

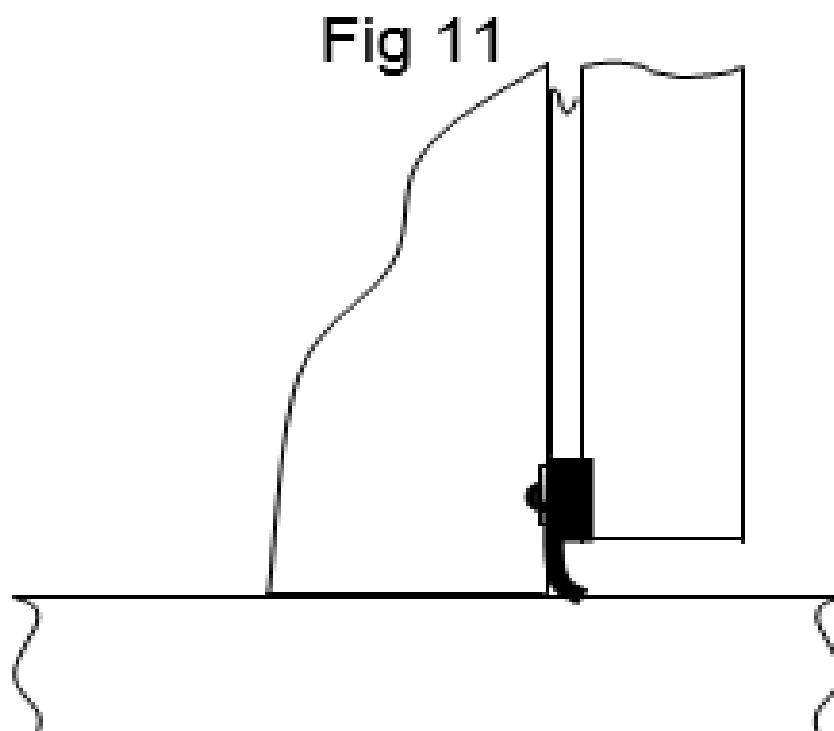

Important Note !

If the ceiling panel has been tipped during installation. The product should not be switched on for 24hrs.



Page left Blank Intentionally



Page left Blank Intentionally



UK Head Office

Foster Refrigerator
Oldmedow Road
Kings Lynn
Norfolk
PE30 4JU

a Division of ITW (UK) Ltd

Tel: +44 (0)843 216 8833
Fax: +44 (0)843 216 4707

Email: support@foster-uk.com

Website: www.fosterrefrigerator.co.uk

Part number: 00-570525